







# Hidden Words



 Use the Word List to complete the sentences.  
Circle each word in the puzzle below.

The Ph \_\_\_\_\_ took the a \_\_\_\_\_ of God. They put it in the  
t \_\_\_\_\_ of their god Dagon. The people got up early the next  
 day. Dagon was lying on the g \_\_\_\_\_! He had fallen on his  
 f \_\_\_\_\_ in front of the ark of the LORD. So they p \_\_\_\_\_ up Dagon.  
  
 They put him back in his place. But the next morning when they got  
  
 up, D \_\_\_\_\_ was lying on the ground a \_\_\_\_\_! He had fallen  
  
 on his face in front of the ark of the LORD. His h \_\_\_\_\_ and hands had  
 been broken off.

Word List
again
ark
Dagon 
face
ground
head
Philistines
picked
temple 

D	A	S	D	A	O	E	H	P	V	N	I	J	M	B	K
N	N	O	G	A	D	N	C	B	I	B	O	Y	F	Z	E
U	M	T	A	O	S	T	Z	A	O	C	Z	R	U	H	M
O	L	R	U	F	U	Y	S	A	F	H	K	H	O	P	P
R	K	H	N	L	M	D	W	G	C	P	X	E	A	E	L
G	V	F	J	E	Z	P	V	A	Q	B	R	A	D	Z	E
F	E	X	D	L	C	B	Q	I	V	V	J	Z	A	M	R
N	I	A	K	P	B	N	C	N	K	D	Z	W	Z	K	I
C	E	J	A	M	S	K	V	D	I	H	G	O	A	C	Y
H	G	H	S	E	N	I	T	S	I	L	I	H	P	C	T
P	H	I	T	T	K	T	I	N	E	S	Q	K	U	X	U
R	I	W	P	P	H	S	X	H	N	T	F	P	H	H	E

# Order Up!



Number the boxes in the order that they happened.  
Color the picture in each box.



The people put the ark on a cart pulled by cows and sent it back to the Israelites with a chest of gold.

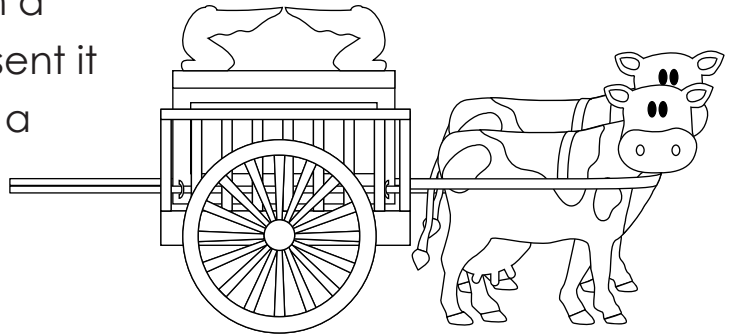

1 Samuel 6:1-12



The Lord's power was against the people. He made them suffer with growths in their bodies. The people said, "The ark of the God of Israel must not stay here with us. His power is against us and against our god Dagon."



1 Samuel 5:6-7



The ark of the LORD's covenant law was brought into the camp. So the Philistines fought. The Israelites lost the battle.

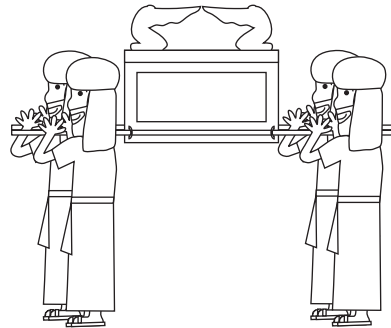

1 Samuel 4:5, 10



The Philistines had captured the ark of God. They carried the ark into the temple of their god Dagon.

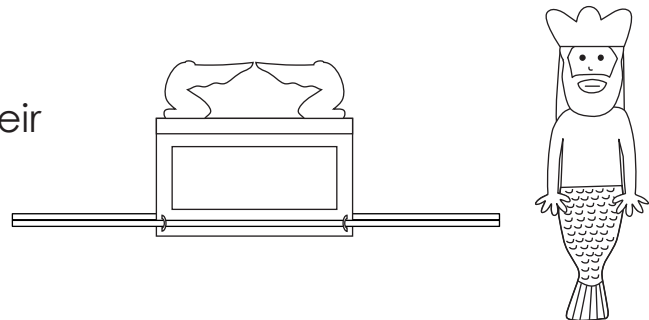

1 Samuel 5:1-2